

# WINCO®

**HPS6000HE/I  
GENERATOR**

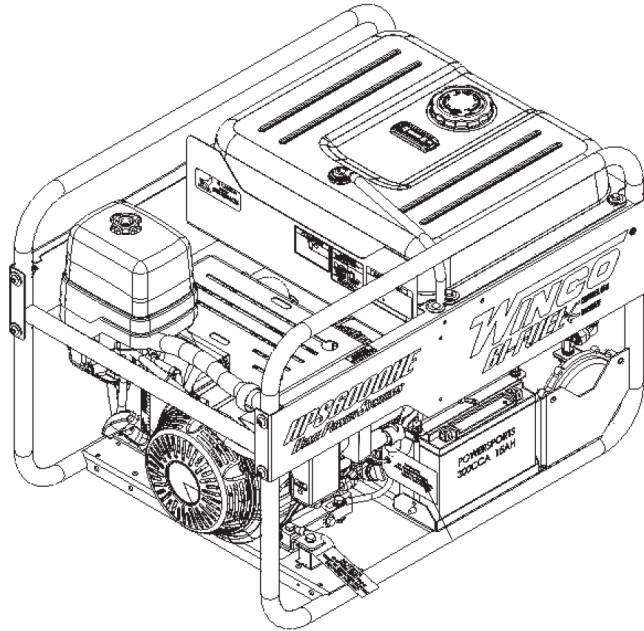

# INSTALLATION AND OPERATORS MANUAL

WINCO INC. 225 S. CORDOVA AVE. LE CENTER, MN 56057 507-357-6821  
SERVICE DEPT. 507-357-6831  
[www.wincogen.com](http://www.wincogen.com)

# TABLE OF CONTENTS

## SAVE THESE INSTRUCTIONS

## SPECIFICATIONS

GENERATOR  
ENGINE

## SAFETY INFORMATION

ANSI SAFETY DEFINITIONS  
CALIFORNIA PROPOSITION 65

## TESTING POLICY

## INTRODUCTION

INTENDED USES  
RESTRICTED USES

## UNIT CAPABILITIES

GENERATOR CONNECTIONS  
STARTING ELECTRIC MOTORS

## PREPARING THE UNIT

UNPACKING  
LUBRICATION  
OIL RECOMMENDATIONS  
GASOLINE  
NG FUEL  
INSTALLING THE FUEL LINE  
FUEL CONSUMPTION  
FUEL PRESSURE

## CHANGING FUEL TYPES

GASOLINE TO NG  
NG TO GASOLINE

## BATTERY INSTALLATION

BATTERY CHARGING

<b>3</b>	<b>OIL ALERT SYSTEM</b>	<b>9</b>
<b>3</b>	<b>OPTIONAL DOLLY KIT</b>	<b>9</b>
	<b>OPTIONAL FUEL SOLENOID KIT</b>	<b>9</b>
<b>4</b>	<b>INITIAL START UP</b>	<b>9</b>
	BASIC OPERATION	
	GASOLINE	
	NATURAL GAS	
<b>5</b>	<b>STARTING HINTS</b>	<b>11</b>
<b>5</b>	COLD WEATHER	
	HOT WEATHER	
	STOPPING AND STORING	
	OPERATING SPEED	
<b>5</b>	<b>CONNECTING THE LOADS</b>	<b>12</b>
	APPLYING THE LOADS	
<b>6</b>	GROUNDING	
	WIRING	
	<b>ENGINE CARE</b>	<b>13</b>
	MAINTENANCE SCHEDULE	
	CHECKING THE OIL LEVEL	
	CHANGING THE OIL	
	DUAL ELEMENT AIR FILTER	
	<b>GENERATOR CARE</b>	<b>14</b>
<b>8</b>	EXERCISING THE GENERATOR	
	GENERATOR MAINTENANCE	
	CLEANING	
	SPARK PLUG	
	CARBON CANISTER	
<b>8</b>	<b>TROUBLESHOOTING</b>	<b>14</b>
	<b>CONTROL PANEL DIAGRAM</b>	<b>15</b>
	<b>24 MONTH LIMITED WARRANTY</b>	<b>16</b>

# SAVE THESE INSTRUCTIONS

This manual contains important instructions that should be followed during installation and maintenance of the generator. Read and understand all instructions in the manual before starting and operating the generator.

## USING THIS MANUAL

Congratulations on your choice of a WINCO generator. You have selected a high-quality, precision-engineered generator designed and tested to give you years of satisfactory service.

To get the best performance from your new generator, it is important that you carefully read and follow the operating instructions in this manual.

Should you experience a problem please follow the "Troubleshooting Tables" near the end of this manual. The warranty listed in the manual describes what you can expect from WINCO should you need service assistance in the future.

## COPY YOUR MODEL AND SERIAL NUMBER HERE

No other WINCO generator has the same serial number as yours. If you should ever need to contact us concerning this unit, it will help us to respond to your needs faster.

MODEL \_\_\_\_\_

SERIAL NUMBER \_\_\_\_\_

PURCHASE DATE \_\_\_\_\_

DEALER NAME \_\_\_\_\_

DEALER PHONE # \_\_\_\_\_

# SPECIFICATIONS

## GENERATOR

Model	HPS6000HE/I
Surge Watts	6,000
Continuous Watts	5,500
Volts	120/240
Amps	45.8/22.9

Generator Manufacturer	Mecc Alte Spa
Generator Model Number	S16W-130/A
Part Number	16346-006
Rotor Resistance	3.95 Ohms
Stator Resistance	0.36 Ohms
Cap Winding Resistance	2.45 Ohms
Capacitors	25 mF
Capacitor Part Number	16346-612

## ENGINE

Engine Manufacturer	Honda
Engine Model Number	GX340
Type	RT2VWE2
Code	GCBET
Spark Plugs	BPR6ES (NGK)
Air Filter	17210-ZE3-505
Air Filter Pre-Cleaner	17218-ZE3-505
Spark Plug Gap	0.030 in
Intake Valve Clearance	0.006 - 0.010 in
Exhaust Valve Clearance	0.010 - 0.012 in
Oil Capacity	38.4 oz (1.2 qts)

# SAFETY INFORMATION

This engine generator set has been designed and manufactured to allow safe, reliable performance. Poor maintenance, improper or careless use can result in potentially deadly hazards; from electrical shock, exhaust gas asphyxiation, or fire. Please read all safety instructions carefully before installation or use. Keep these instructions handy for future reference. Take special note and follow all warnings on the unit labels and in the manuals.

## ANSI SAFETY DEFINITIONS

### DANGER:

*DANGER indicates an imminently hazardous situation which, if not avoided, will result in death or serious injury. This signal word is to be limited to the most extreme situations.*

### WARNING:

*WARNING indicates a potentially hazardous situation which, if not avoided, could result in death or serious injury.*

### CAUTION:

*CAUTION indicates a potentially hazardous situation which, if not avoided, may result in minor or moderate injury. It may also be used to alert against unsafe practices.*

#### 1. ELECTRICAL SHOCK -

The output voltage present in this equipment can cause fatal electric shock. This equipment must be operated by a responsible person.

- A. Do not allow anyone to operate the generator without proper instruction.
- B. Guard against electric shock.
- C. Avoid contact with live terminals or receptacles.
- D. Use extreme care if operating this unit in rain or snow.
- E. Use only three-pronged grounded receptacles and extension cords.
- F. Be sure the unit is properly grounded to an external ground rod driven into the earth.

#### 2. FIRE HAZARD -

Gasoline and other fuels present a hazard of possible explosion and/or fire.

- A. Do not refuel when the engine is running or hot.
- B. Keep fuel containers out of reach of children.
- C. Do not smoke or use open flame near the generator set or fuel tank.
- D. Keep a fire extinguisher nearby and know its proper use. Fire extinguishers rated ABC by NFPA are appropriate.
- E. Store fuel only in an approved container, and only in a well ventilated area.
- F. Follow local codes for closeness to combustible material.

#### 3. DEADLY EXHAUST GAS -

Exhaust fumes from any gasoline engine contain carbon monoxide, an invisible, odorless and deadly gas that must be mixed with fresh air.

- A. Operate only in well ventilated areas.
- B. Never operate indoors including attached garages
- C. Never operate the unit in such a way as to allow exhaust gases to seep back into closed rooms (i.e. through windows, walls, floors).

#### 4. NOISE HAZARD -

Excessive noise is not only tiring, but continual exposure can lead to loss of hearing.

- A. Use hearing protection when working around this equipment for long periods of time.
- B. Keep your neighbors in mind when using this equipment.

#### 5. CLEANLINESS -

Keep the generator and surrounding area clean.

- A. Remove all grease, ice, snow or materials that create slippery conditions around the unit.
- B. Remove any rags or other materials that could create a potential fire hazard.
- C. Carefully clean up any gas or oil spills before starting the unit.

#### 6. SERVICING EQUIPMENT -

All service, including the installation or replacement of service parts, should be performed only by a qualified technician.

- A. Use only factory approved repair parts.
- B. Do not work on this equipment when fatigued.
- C. Never remove the protective guards, covers, or receptacle panels while the engine is running.
- D. Use extreme caution when working on electrical components. High output voltage from this equipment can cause serious injury or death.
- E. Always avoid hot mufflers, exhaust manifolds, and engine parts. They can cause severe burns instantly.
- F. The use of the engine-generator set must comply with all national, state, and local codes.

## CALIFORNIA PROPOSITION 65



**WARNING:** *This product contains crude oil, gasoline, diesel fuel and other petroleum products, Antifreeze to which can expose you to chemicals including toluene and benzene, Ethylene glycol (ingested) which are known to the State of California to cause cancer, birth defects or other reproductive harm and developmental issues. For more information go to [www.P65Warning.ca.gov](http://www.P65Warning.ca.gov).*

# TESTING POLICY

Before any generator is shipped from the factory, it is fully checked for performance. The generator is loaded to its full capacity, and the voltage, current, and frequency are carefully checked.

Rated output of generator is based on engineering tests of typical units, and is subject to, and limited by, the temperature, altitude, fuel, and other conditions specified by the manufacturer of applicable engines.

# INTRODUCTION

## INTENDED USES

This engine generator set has been designed primarily for portable use. Both 120 volt and 240 volt receptacles are provided in the control panel to plug in your loads (lights, portable tools, and small appliances). These units are dual wound generators, therefore the 120 volt loads must be equally split with 1/2 of the rated capacity available on each of the two 120 volt circuits.

This portable unit requires large quantities of fresh air for cooling the engine and generator. For safety, long life and adequate performance, these units should never be run in small compartments without positive fresh air flow.

## RESTRICTED USES

**DO NOT** remove from the cradle assembly. Removal of the generator from the cradle assembly may cause excessive vibration and damage to the engine-generator set.

**DO NOT** operate and/or store the unit outside during inclement weather without adequate protection from the elements. Failure to do so will damage the unit.

**DO NOT** install and operate this generator in a small compartment, i.e. generator compartments of vehicles, motor homes or travel trailers. These compartments will not allow enough free flow of fresh air to reach the engine generator set for cooling and will cause the unit to overheat, damaging both the engine and generator. Small compartments will also develop hot spots where there is very little air flow and may cause a fire.

**PLEASE NOTE** There are 3rd party companies making enclosures for generators that have been properly engineered. The use of these 3rd party enclosures is acceptable as long as they have been certified and meet current code.

**DO NOT** attempt to operate at 50 cycles. These units are designed and governed to operate at 60 cycles only.

# UNIT CAPABILITIES

## GENERATOR CONNECTIONS

HPS6000HE/I: 120 Volt and 240 Volt receptacles are provided for connection to various loads. The diagram below represents this 5,500 watt (rated output) generator. A & B represent the 120 volt output legs of this generator. Up to 2,250 watts at 120 volts (22.9 Amps) can be drawn from the receptacles attached to either A or B output legs. This generator is capable of producing 22.9 Amps of 240 volt current at C. Check the appliance or tool nameplates for the current and voltage to insure compatibility. Remember that power taken from C reduces the power available at equally both A and B and vice versa.

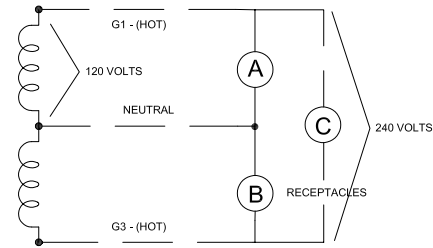

## STARTING ELECTRIC MOTORS

Electric motors require much more current (amps) to start them than to run them. Some motors, particularly low cost split-phase motors, are very hard to start and require 5 to 7 times as much starting current as running current. Capacitor motors are easier to start and usually require 2 to 4 times as much starting current as running current. Repulsion Induction motors are the easiest to start and require only 1 1/2 to 2 1/2 times as much starting as running current.

Most fractional horsepower motors take about the same amount of current to run them whether they are Repulsion Induction (RI), Capacitor (Cap), or Split-Phase (SP) type.

If the electric motor is connected to a hard starting load such as an air compressor, it will require more starting current. If it is connected to a light load, or no load such as a power saw, it will require less starting current. The exact requirement will also vary with the brand or design of the motor.

Self-exciting generators respond to severe overloading differently than utility power. When overloaded, the engine is not able to supply enough power to bring the electric motor up to operating speed. The generator responds with high initial starting current, but the engine speed drops sharply. The overload may stall the engine. If allowed to operate at very low speeds, the electric motor starting winding will burn out in a short time. The generator winding might also be damaged.

### CAUTION: EQUIPMENT DAMAGE

*Running the generator set under these conditions may result in damage to the generator stator as well as the motor winding.*

The heavy surge of current required for starting motors is required for only an instant. The generator will not be damaged if it can bring the motor up to speed in a few seconds of time. If difficulty is experienced in starting motors, turn all other electrical loads off and if possible reduce the load on the electric motor.

# PREPARING THE UNIT

## UNPACKING

### CAUTION: EQUIPMENT DAMAGE

*THIS UNIT HAS BEEN SHIPPED WITH OIL. Failure to maintain the engine oil at the proper level will result in serious engine damage.*

When you unpack your engine-generator set be sure to remove all the information sheets and manuals from the carton.

1. As you receive your unit, it is critical to check it for any damage. If any damage is noted, it is always easiest to refuse the shipment and let WINCO take care of the freight claim. If you sign for the unit, the transfer of the ownership requires that you file the freight claim

2. Before proceeding with the preparations of your new generator for operation, take a couple of minutes to ensure the unit you have received is the correct model and review the specification pages in this manual to ensure that this unit meets your job requirements.

## LUBRICATION

Before starting the engine, check the oil level. The recommended grade oil and quantity of oil required is listed in the engine operator's manual and under the service tab in this manual. This unit was shipped with oil. The engine normally holds 34.8 ounces (1.2 quarts) of oil. When filling the crankcase, use the dipstick to ensure that you do not over fill the crankcase. The full oil level mark on the dipstick is depicted in the following image.

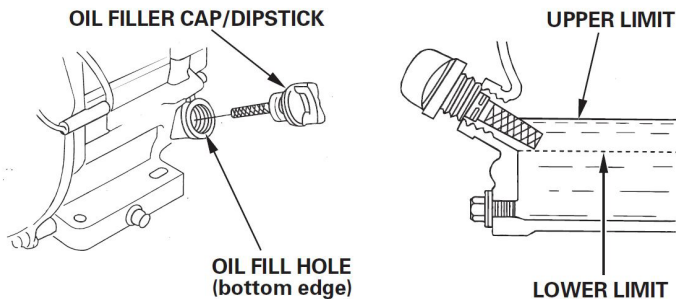

Oil is added to the engine by removing the oil cap and adding oil at this point. After filling the crankcase to the proper level, be sure you properly tighten the oil fill cap.

NOTE: This engine generator must be on a level surface before you check or add oil to the system.

The necessity of using the correct oil and keeping the crankcase full cannot be overemphasized. Engine failures resulting from inadequate or improper lubricant are considered abuse and not covered by the generator or engine manufacturer's warranty.

## OIL RECOMMENDATIONS

Outdoor temperatures determine the proper oil viscosity for the engines. Use the chart to select the best viscosity for the outdoor temperature range expected.

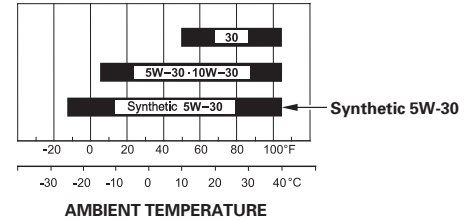

SAE 10W-30 or 5W-30 is recommended for general use. Use a full synthetic 5W-30 for starting/operating temperatures between 5°F (-15°C) and -13°F (-25°C). Other viscosities shown in the chart may be used when the average temperature in your area is within the indicated range.

## GASOLINE

When using gasoline, always use fresh, clean, unleaded fuel. This engine is certified to operate on unleaded gasoline with a minimum octane rating of 87 or higher. Gasoline containing no more than 10% ethanol is accepted.

### CAUTION: EQUIPMENT DAMAGE

*Do not use unapproved gasolines, such as E15 or E85. Do NOT mix oil in the gasoline. Use of unapproved fuels will damage the engine components and void the engine warranty.*

Use of fuels with content of ethanol greater than shown above, may cause starting and/or performance problems. Always ensure that the fuel is clean and free of all debris.

### WARNING: FIRE DANGER

*Gasoline and its fumes are VERY explosive when proper precautions are not taken.*

Never use gasoline that has been stored for an extended period of time as the fuel will lose its volatile properties and you will be left with varnish residue.

The use of additives, such as STA-BIL, or an equivalent, will minimize the formation of fuel gum deposits. If a unit has been out of operation for an extended period of time, it is best to drain old fuel from the engine and replace with fresh fuel before attempting to start.

See the engine manual for special instructions for operating this unit over 5000 feet.

## NG FUEL

The information in this manual is offered to assist you in providing the proper vapor fuel supply for your engine. This information is only provided to advise you of the engine's requirements and the decisions you must make. In no case should this information be interpreted to conflict with any local, state, or national codes. In if doubt, always follow local codes.

**DANGER: FIRE/PERSONAL INJURY**

All fuel lines must be installed by a qualified fuel supplier.

The fuel source should be as close as possible to the outdoor operating location. This will reduce the installation cost of fuel runs. Connect the fuel supply line to the inlet of the fuel demand regulator on the unit using a locally approved flexible fuel line (see table for recommended line size). The pressure supplied to the demand regulator must be 4 to 6 ounces or 7 to 11 inches w.c. (water column). The primary regulator at the fuel supply must be capable of delivering the proper volume of fuel at this pressure.

Have your local fuel supplier install a protected fuel connection at the outside operating location. They should also install a lockable fuel shut off valve at the connection point. An approved flexible fuel line must be installed between the engine generator set and the supply line.

**DANGER: FIRE/PERSONAL INJURY**

The NG fuel supply line must always be shut off when the engine is not running. Failure to do so may allow fuel to leak at the unit.

**INSTALLING THE FUEL LINE**

**DANGER: PERSONAL INJURY**

Units that are intended to be run unattended MUST have an electric fuel solenoid installed. This solenoid MUST be wired to AUTOMATICALLY turn off the fuel whenever the engine stops.

Unit location will determine the size of fuel line the is required to supply the engine with a constant fuel pressure. Refer to the tables below for fuel line size and recommended tank size. For distances of 100 feet and over, a two regulator fuel system is recommended. This system consisting of a primary 10-15# regulator at the tank and a 6 ounce secondary regulator installed about 10 feet from the generator. You need to run a 3/4 inch line or larger from the secondary regulator to the engine-generator set. When a two (2) regulator fuel system is used, a fuel line size of 3/8 inch is generally adequate for distances up to 300 feet. The line size from the table below applies to the distance from the second regulator to the demand regulator. A positive fuel shut-off device must be installed in the fuel line close to the engine-generator set. This manual shut-off valve is required by code even if the 12 Volt fuel solenoid kit is installed. This optional 12 Volt DC valve is available through your local WINCO dealer and can be used to shut off during normal periods of operation without having to shut off the manual valve.

The fuel line used to connect the supply line to the demand regulator must be a locally approved flexible fuel line. Products used will vary in different regions depending on availability and local codes. Consult with your local fuel supplier to ensure complete compliance with ALL codes.

1. Remove the plastic cover plug from the demand regulator.
2. Connect the flex fuel line to the demand regulator or the optional solenoid.

**DANGER: PERSONAL INJURY**

Do NOT use galvanized pipe in the fuel line runs. The galvanized coating will become eroded and flake off, causing possible obstruction or damage to the regulator or fuel valve. The obstruction could cause an inoperative engine or an explosive fuel leak.

Size of pipe required for generators operating on NG gas.

Length of fuel line*	Fuel line size
Less than 25 feet	3/4" in black pipe
25-100 Feet	1 in black pipe
Over 100 feet	Not recommended**

\*Allow an additional 3 feet for each standard elbow. Do not use 'street ells' (restrictive).

\*\*Consult factory for fuel run over 100 feet.

**DANGER: FIRE/PERSONAL INJURY**

Be careful when sealing gas joints. Excessive sealing compound can be drawn into the solenoid, regulator, or carburetor causing an engine malfunction or dangerous fuel leak.

**FUEL CONSUMPTION**

(Full Load)		
Gasoline	1 gal/hr	
Natural Gas	160 ft <sup>3</sup> /hr	163,200 BTU/hr

**FUEL PRESSURE**

Correct fuel pressure cannot be stressed enough. The most common cause for inoperative systems is an inadequate or incorrect fuel pressure. Power and performance of the engine is in direct relation to the correctness of the fuel system. The following diagram is of a typical NG installation.

**NATURAL GAS**

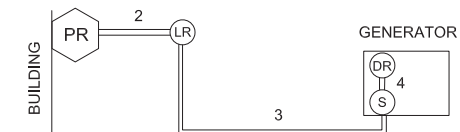

LEGEND:

- PR - PRIMARY REGULATOR (Fuel Meter)
- LR - LOW PRESSURE REGULATOR (Reduces fuel pressure to 4 to 6 oz. (ounces per square inch) IF REQUIRED)
- S - FUEL SOLENOID VALVE (Positive shut-off solenoid)
- DR - DEMAND REGULATOR (Requires engine vacuum to open)

Reference numbers 2 and 3 in the previous diagram are system parts supplied by the customer. Reference number 4 is the engine-generator set. The following table is of the fuel pressure reading at each reference in the system.

Natural Gas Fuel Pressure Table

	2	3	4
UNIT OFF	LINE PSI	7-11 in	7-11 in
		4-6 oz	4-6 oz
STARTING	LINE PSI	7-11 in	7-11 in
		4-6 oz	4-6 oz
NO LOAD	LINE PSI	7-11 in	7-11 in
		4-6 oz	4-6 oz
FULL LOAD	LINE PSI	7-11 in	7-11 in
		4-6 oz	4-6 oz

Remember that whichever fuel delivery system or type of vapor fuel used, the fuel pressure at the demand regulator installed on the engine generator must be between 4 and 6 oz (7-11 inches of water column). Any lower pressure and the unit will starve for fuel under load. Any higher and the unit will 'flood' when attempting to start.

## CHANGING FUEL TYPES

These engine-generator sets are designed to run on two different fuels; gasoline and natural gas. They may be easily changed from one fuel to another.

### GASOLINE TO NG

1. With the engine running, turn off the gasoline valve.
2. Run the engine until it runs out of fuel.
3. Remove the plastic insert from the demand regulator.
4. Install a locally approved flexible fuel line.
5. Connect the NG fuel line to the flexible fuel line. You can't connect the ridged mounted pipe directly.
6. Turn on the vapor fuel.
7. Start the engine.
8. Apply the load to the generator.

### NG TO GASOLINE

1. With the engine running turn off the NG fuel supply.
2. Run the engine until it runs out of fuel.
3. Remove the flexible fuel line from the demand regulator.
4. Reinstall the plastic insert in the regulator.
5. Check to be sure the gasoline fuel valve is off.
6. Fill the gasoline fuel tank.
7. Turn on the gasoline fuel valve.
8. Start the engine.

If the optional Fuel Solenoid kit has been installed on the unit, all vapor fuel connection will be made at the 12 Volt gas valve.

## BATTERY INSTALLATION

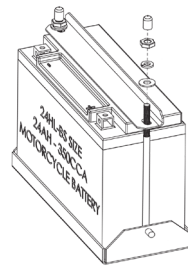

This engine-generator set is shipped with a battery tie down kit for customer installation. This kit consists of a battery tie down and hardware for installation of the customer supplied battery to operate it.

This engine-generator set is designed for recoil and electric start. You will need to purchase and install a battery to operate it on Natural Gas or for electric start with gasoline.

A 12 Volt battery, BCI group 20 OR 24HL rated at 300 CCA or larger is recommended for the electric start on this engine-generator set. Maximum length: 8 1/8", Maximum width: 3 9/16", Height range: 5 3/4" - 7", Amp Hours: 15AH or greater. Follow the battery manufacturers recommendations for servicing and charging prior to use. Connect the battery to the electric start system using the cables provided.

### CAUTION: EQUIPMENT DAMAGE

*These electric start engines are NEGATIVE GROUND. Use extreme caution when connecting the battery. Connect the Negative battery terminal to GROUND. Connecting the positive battery terminal to ground will damage the engines charging circuit.*

For your safety, always connect the positive battery cable to the 'bat+' terminal first. Then connect the negative battery cable to the 'bat-' terminal. Make sure all connections are clean and tight. Reverse the sequence when disconnecting, disconnect the negative cable first. The engines produce enough direct current to keep the battery charged under normal operating conditions, but were not intended to be used as a battery charger.

### WARNING: PERSONAL INJURY

*Lead acid batteries produce explosive hydrogen gas when charging. Keep sparks, flames, and burning cigarettes away from the battery. Ventilate the area when charging or using the battery in an enclosed space. Lead acid batteries contain sulfuric acid, which causes burns. If acid contacts eyes, skin, or clothing, flush well with water. For contact with eyes, get immediate medical attention.*

## BATTERY CHARGING

Units equipped with electric start have a small flywheel charger built into the engine flywheel assembly for recharging the start battery. This flywheel charger generates a small AC current that passes through a diode assembly to produce a DC charging current of about 1 to 3 AMPS. This circuit is not designed to be used as a battery charging circuit to recharge dead batteries.



# OIL ALERT SYSTEM

This generator is equipped with a low oil shutdown system. The HONDA engine uses a float switch mounted inside the engine. If the oil level drops below a certain point, the low oil module on the engine will shut it down. This oil warning system will automatically stop the engine before the oil level reaches a critical danger point. This feature is designed to prevent costly repairs and downtime.

### CAUTION: EQUIPMENT DAMAGE

Allowing the engine to shutdown repeatedly on low oil level, may cause excessive wear which can be cumulative.

# OPTIONAL DOLLY KIT

An optional dolly kit is available for this generator. The dolly kit comes with instructions and a parts list. After installing the dolly kit, file the instructions and parts list in the back of this manual for future reference.

# OPTIONAL FUEL SOLENOID KIT

An optional 12 Volt DC fuel solenoid kit is available for this generator. This solenoid kit will automatically shut off the fuel supply should the engine stop for any reason, preventing fuel leaks. This kit is recommended if you are going to be operating the generator unattended.

# INITIAL START UP

The throttle control on these generators is preset and locked to operate at 3600 RPM (nominal) with no load speed set at 3690 RPM. Only a trained service technician should be allowed to adjust this speed setting.

### NOTICE: ENGINE START LOCKOUT

This unit will not start if it is low on oil. The lubricating oil level must be at the full mark before the engine will start and run.

# BASIC OPERATION

If the engine is cold and stiff or if the battery is not fully charged, starting can be made easier by slowly hand cranking the engine through the compression stroke before pushing the starter switch. This permits the starter to gain momentum before the heavy load of the compression stroke occurs. This minimizes the drain on the battery and improves the possibility of starting under such adverse conditions. Always keep the battery charged, especially during cold weather operation.

# GASOLINE MANUAL STARTING

1. Check oil level, refill as needed.
2. Turn on the fuel supply by moving the fuel lever to the 'ON' position.

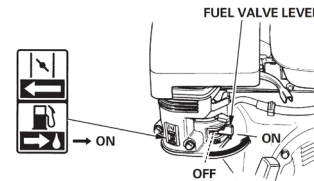

NOTE - There is a second fuel valve under the fuel tank that is used when removing the tank. This valve is normally left on.

3. Move the choke lever to the 'CLOSED' position. To restart a warm engine, leave the choke lever in the 'OPEN' position.

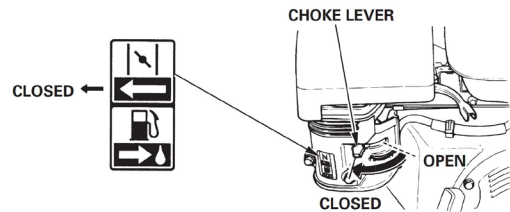

4. Turn the engine switch to the "on" position.

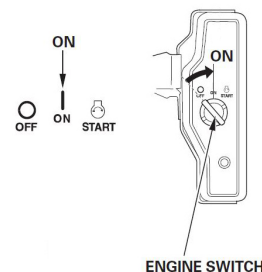

- Pull the starter grip lightly until resistance is felt, then pull briskly.
- When the engine starts, open the choke gradually.
- The engine should promptly come up to operating speed.

**NOTICE:**

Do not allow the starter grip to snap against the engine. Return it gently to prevent damage to the starter.

**CAUTION: EQUIPMENT DAMAGE**

Never permit the choke to remain on after the engine has run for a short time. It is not necessary to choke the engine when it is warm. Avoid over-chocking.

**ELECTRIC STARTING**

If the engine is cold and stiff, or if the battery is not fully charged, starting can be made easier by slowly hand cranking the engine through the compression stroke before pushing the starter switch. This permits the starter to gain momentum before the heavy load of the compression stroke occurs. This minimizes the drain on the battery and improves the possibility of starting under such adverse conditions. Always keep the battery charged, especially during cold weather operation.

- Check oil level, refill as needed.
- Turn on the fuel supply by moving the fuel lever to the 'ON' position.

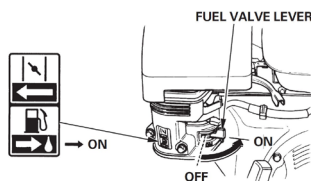

- Move the choke lever to the 'CLOSED' position. To start a warm engine, leave the choke lever in the 'OPEN' position.

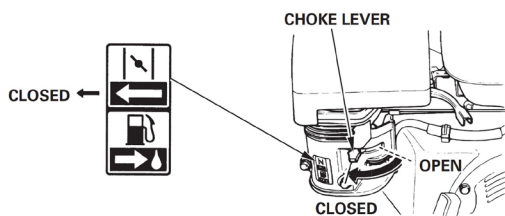

- Turn the engine switch to the 'ON' position.
- Operating the stater. Rotate the switch briefly to the START position. The starter life is improved by using shorter starting cycles with time to cool off between cranking cycles. Do not operate the starter more than 5 seconds and wait at least 10 seconds before operating the starter again. Repeat cycle if necessary.

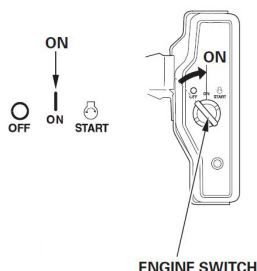

- When the engine starts, release the engine switch, allowing it to return to the 'ON' position.
- Gradually move choke to the open position as the engine warms up.
- The engine should promptly come up to operating speed.

**CAUTION: EQUIPMENT DAMAGE**

Never permit the choke to remain on after the engine has run for a short time. It is not necessary to choke the engine when it is warm. Avoid over-chocking.

**NATURAL GAS  
ELECTRIC STARTING**

When operating on NG, you will have to always use the electric start to get the unit running. Because the engine vacuum needs to activate the fuel system it is almost impossible to manual start the unit using NG.

- Check oil level, refill as needed.
- Turn on the NG fuel supply.
- NEVER use the choke when operating on NG.
- Turn the engine switch to the 'on' position.
- Operating the starter. Rotate the key switch briefly to START position. The starter life is improved by using shorter starting cycles with time to cool off between cranking cycles. Do NOT operate the starter more than 5 seconds and wait at least 10 seconds before operating the starter again. Repeat cycle if necessary.

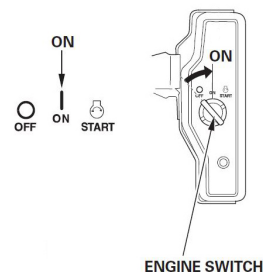

- When the engine starts, release the key switch, allowing it to return to the 'on' position.
- The engine should promptly come up to operating speed.

# STARTING HINTS

## COLD WEATHER

- A. Use the proper oil for the temperature expected.
- B. Use fresh winter grade fuel. Winter grade gasoline is blended to improve starting. Do not use summer grade gasoline.

## HOT WEATHER

- A. Use the proper oil for the temperature expected.
- B. Use only summer blended gasoline. Using gasoline left over from winter may cause the unit to vapor lock.

## STOPPING AND STORING

- 1. Move the key to the "OFF" position.
- 2. Turn off the fuel supply valve.
- 3. Before extended storage (over 30 days) certain precautions must be taken to ensure the fuel doesn't deteriorate and clog the fuel system.

**NOTE:** The use of a fuel additive, such as Sta-Bil or equivalent will minimize the formation of gum deposits during storage. The additive may be added to gasoline in the engines fuel tank or to gasoline in a storage container.

- A. Add the fuel stabilizer to the fuel in the tank and run for 2 minutes to circulate the stabilizer throughout the fuel system.
- B. If you choose to remove the remaining fuel from the fuel tank, it must be drained into an approved container.
- C. Start the engine and allow it to run until all the fuel in the carburetor and the fuel lines has been used up and the engine stops.

**NOTE:** Running the engine to use up the fuel in the lines and carburetor will still leave a small amount of fuel in carburetor. It is best extended storage to treat the fuel before draining.

- D. While the engine is warm, drain the oil and refill with fresh oil.
- E. Clean dirt and chaff from cylinder, cylinder head fins, blower housing, screen, and muffler areas.
- F. Store in a clean and dry area.

## OPERATING SPEED

The engine-generator must be run at the correct speed in order to produce the proper electrical voltage and frequency.

### CAUTION: EQUIPMENT DAMAGE

*The output voltage should be checked to ensure the generator is working properly prior to connecting a load to the generator. Failure to do so could result in damage to equipment plugged into the unit and possible injury to the individual.*

All engines have a tendency to slow down when a load is applied. When the electrical load is connected to the generator, the engine is more heavily loaded, and as a result, the speed drops slightly. This slight decrease in speed, together with the voltage drop within the generator itself, results in a slightly lower voltage when the generator

is loaded to its full capacity than when running no load. The slight variation in speed also affects the frequency of the output current. This frequency variation has no appreciable effect in the operation of motors, lights, and most appliances. However, electronic equipment and clocks will be affected if correct RPM is not maintained. See Load vs. Output chart.

Although individual units and models vary slightly, the normal voltage and frequency of the engine-generator described in this manual are approximately as follows, under varying loads:

LOAD vs. OUTPUT			
Generator Load	Speed (RPM)	Frequency (Hz)	Voltage
None	3690	61.5	125V
Half	3600	60.0	120V
Full	3510	58.5	115V

The speed of the engine was carefully adjusted at the factory so that the generator produces the proper voltage and frequency. For normal usage, the speed setting should not be changed. If the generator is being run continuously on a very light load, it is often advisable to lower the operating speed slightly.

### CAUTION: EQUIPMENT DAMAGE

**SPEED ADJUSTMENTS SHOULD ONLY BE MADE BY A QUALIFIED SERVICE TECH.** *Whenever making any speed adjustments, check the unit with a voltmeter and a frequency meter or a tachometer and be sure the voltage and speed are correct.*

Lower voltage may damage both the generator and any load connected to it. Running the engine at excessively high speeds results in high voltage, which may significantly shorten the life of appliances being used.

Output voltage should be checked periodically to ensure continued proper operation of the generating plant and appliances. If the generator is not equipped with a voltmeter, it can be checked with a portable meter.

# CONNECTING THE LOADS

## APPLYING THE LOADS

Allow the engine to warm up for two or three minutes before applying any load. This will allow the engine to reach normal operating temperature and oil to circulate throughout the engine. A short warm-up time will permit the engine to work more efficiently when the load is applied and will reduce the wear in the engine, extending its life.

Receptacles have been provided to allow loads to be connected to the generator. The loads should be added one at a time. If a large motor is being started: or multiple motors are being started, they should be started individually and the largest should be started first.

### CAUTION: EQUIPMENT OVERLOAD

*Keep the generator load within in the generator and receptacle nameplate rating. Overloading may cause damage to the generator and/or the loads.*

Most electric tools and appliances will have the voltage and amperage requirements on their individual nameplates. When in doubt, consult the manufacturer or a local electrician. The nameplate amperage rating for electric motors can be misleading. See "Starting Electric Motors" in the Unit Capabilities.

These engine-generator sets are inherently self regulating based on engine speed. The engine governor will automatically adjust itself to the load. No harm to the generator will result if it is operated with no load connected. Proper utilization of the receptacles located on the control panel is necessary to prevent damage to either the receptacles or the generator. The generator is a limited source of electrical power, therefore, pay special attention to the receptacle and generator ratings. The nameplate rating can be obtained through a single receptacle as long as the receptacles amperage rating is not exceeded.

## GROUNDING

Proper grounding of your generator is application dependent. Carefully evaluate your planned use of your generator to understand which grounding you require. If you are not sure what to do, contact a competent professional to assist you. The NFPA 70 250:34-35 are good technical references.

### STANDARD PORTABLE GENERATOR

Your WINCO portable generator ships with a bonded neutral. You can safely use this generator without external grounding as long as all loads are powered through the receptacle panel.

### VEHICLE-MOUNTED GENERATOR

Your WINCO portable generator ships with a bonded neutral. When mounted to a vehicle to safely distribute power it is necessary that the generator frame is bonded to the vehicle frame. The generator should only supply equipment that is cord and plug connected through receptacles mounted on the generator or the vehicle.

## PERMANENTLY INSTALLED GENERATORS

This WINCO portable generator ships with a bonded neutral and overcurrent protection. NFPA 70 refers to this as a "separately derived system." When connecting it to a building a transfer switch specifically designed for GFCI and bonded neutral generators is required.

## WIRING

Plug your tools such as drills, saws, blowers, sump pump, and other items to be powered directly into the generator receptacles. Before plugging in all the tools and cord sets, recheck the rating of the generator set. Be sure it can handle the intended load and is compatible with the voltage, phase, and current ratings. 'Hard wiring' this unit directly into a temporary construction site electrical system is **NOT A SIMPLE DO-IT-YOURSELF JOB**. For your safety, all wiring must be done by a qualified electrician and conform to the National Electric Code and comply with all state and local codes and regulations. Check with local authorities before proceeding.

### WARNING: PERSONAL DANGER

*A fully isolated, double pole double throw manual transfer switch must be installed any time a generator is being connected to an existing distribution system.*

1. These engine-generator sets are designed for portable heavy duty commercial use. Receptacles are provided on the control panel to permit 120 and 240 Volt portable appliances and tools to be plugged directly into them. Please note that the 3-wire 240 Volt receptacle(s) on these units are designed to power only 240 Volt tools. There are two hot leads and a ground wire, but no neutral connection, in the 3-wire 240 Volt receptacle. A 4-wire receptacle (two hot, one ground, and one neutral) has been provided on the control panel for use in temporary power applications requiring 120/240 Volt power. Consult a licensed electrician for wiring the TemPower plug and connecting it as temporary service.

To connect these units directly to an un-powered, isolated construction site TemPower panel, have your electrician connect to the control panel using a 120/240 Volt, 4-wire twist-lock plug (L14-30).

**NOTE:** Never attempt to use the 240 Volt 3-wire receptacle to wire into a building. This is a GFCI circuit and is designed for 240 Volt output only. It has no neutral connection. If you attempt to draw 120 Volt from this receptacle, the GFCI breaker will trip.

2. If the generator set is connected to an existing distribution system, a fully isolated manual transfer switch must be installed. The transfer switch prevents damage to the generator and the other circuit components if main line power is restored while the generator is connected. Installing a transfer switch also permits the use of normal fusing.
3. Many homes and construction sites are wired for at least 60 to 100 Amp entrance service, much greater than the capacity of this portable generator. When installing the generator at these sites, a secondary emergency distribution panel may have to

be installed. The emergency distribution panel must be installed by a licensed electrician according to all applicable codes. The electrician will move the critical circuits to be powered during the outage to the emergency panel. Keep in mind only a limited amount of amperage is available from the generator set. Some circuit breakers may still have to be turned off to prevent an overload on the generator during the initial start up. See the nameplate on your generator for the amperage capabilities of your unit.

### CAUTION: EQUIPMENT DAMAGE

Failure to properly limit and balance the load applied to the generator will cause the generator to produce low voltage and may damage the engine generator set. It may also cause severe damage to the loads connected to the generator at that time. Improper loading of the generator set constitutes abuse and will not be covered by warranty.

## ENGINE CARE

### MAINTENANCE SCHEDULE

If major engine service or repair is required, contact an authorized engine service center. The manufacturer of these engines has established an excellent world-wide engine service organization. Engine service is very likely available from a nearby authorized dealer or distributor.

REGULAR SERVICE PERIOD (3) Perform at every indicated month or operating hour interval, whichever comes first.		Each Use	First Month or 20 Hrs	Every 3 Months or 50 Hrs	Every 6 Months or 100 Hrs	Every Year or 300 Hrs	Refer to Page
ITEM							
Engine oil	Check level	○					9
	Change		○		○		9
Reduction case oil (applicable types)	Check level	○					9
	Change		○		○		10
Air filter	Check	○					10
	Clean			○ (1)	○ * (1)		10 - 11
	Replace					○ * * *	
Sediment cup	Clean				○		12
Spark plug	Check-adjust				○		12
	Replace					○	
Spark arrester (applicable types)	Clean				○		13
Idle speed	Check-adjust					○ (2)	13
Valve clearance	Check-adjust					○ (2)	Shop manual
Combustion chamber	Clean	After every 500 Hrs. (2)					Shop manual
Fuel tank & filter	Clean				○ (2)		Shop manual
Fuel tube	Check	Every 2 years (Replace if necessary) (2)					Shop manual

### CHECKING THE OIL LEVEL

The oil level must always be checked before the engine is started. Refer to the lubrication section of this manual for instructions on checking the oil level. Take care to remove any dirt or debris from around the oil plug before removing. Be sure the oil level is maintained.

## CHANGING THE OIL

Refer to the Maintenance Schedule Chart for required oil change intervals.

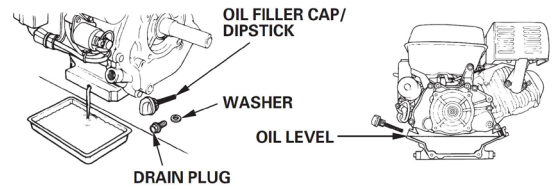

- Start the engine and warm it up, stop the engine and remove the spark plug wire to prevent it from accidentally being started.
  - Remove the oil drain bolt at base of the engine and drain the oil into an approved container.
  - Replace the oil drain bolt making sure the sealing washer is in place.
  - With the engine in a level position, fill with new oil. Refer to the table in the Oil Recommendation section in this manual.
- NOTE: This engine requires 38.4 ounces (1.2 qt) of oil if completely drained. Use caution when refilling the engine as some residual oil may have remained in the engine. Always use the dipstick when filling the engine with oil to prevent overfilling.
- Replace filler plug.
  - Start engine up and warm it up.
  - After warming up the engine, recheck the oil level and refill as necessary to bring it to the proper level.

## DUAL ELEMENT AIR FILTER

Clean and/or replace the foam pre-cleaner and the air filter annually or every 100 hours. Service more often under dusty conditions.

### WARNING: EQUIPMENT DAMAGE

Never start or run the engine with the air filter removed.

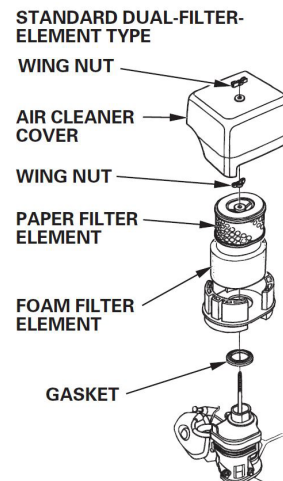

- Remove the wing nut from the air cleaner cover and remove cover.
  - Remove the wing nut from the air filter and remove the filter.
  - Remove the foam filter elements from the paper filter element.
  - Inspect both filter elements and replace them if damaged.
- Always replace the paper filter element at the scheduled interval.

- E. To loosen debris, gently tap the air filter on a hard surface. If the air filter is excessively dirty replace with a new filter. You can use pressurized air (not to exceed 30 psi) to clean the filter. Always blow the compressed air from inside to the outside.
- F. Wash the foam filter element in liquid detergent and water. Then allow it to thoroughly air dry. Dip the foam filter element in clean engine oil and squeeze out all the excess before reinstalling it. The engine will smoke when started if too much oil is left in the foam.
- G. Clean the dirt from the inside of the air cleaner body and cover. Reinstall the air filter in housing making sure the packing is in place beneath the filter element. Tighten the wing nut securely.
- H. Install and secure the cover.

## SPARK PLUG

Replace annually or every 300 hours of operation. Always replace with the same spark plug that came in the engine and check gap before installing. Spark plug gap is 0.030". Poor spark will also occur if spark plug wire does not fit firmly on spark plug. If this happens, reform the terminal to fit firmly on spark plug tip.

## CARBON CANISTER

Designed to collect, store, and dispose of fuel vapors created in the fuel tank/fuel system. The canister should last the life of the unit as long as it stays dry.

## GENERATOR CARE

Proper care and maintenance of the generator is necessary to ensure a long trouble-free life.

## EXERCISING THE GENERATOR

The generator should be operated every three to four weeks. It should be operated for a period of time sufficient to warm the unit up and to dry out any moisture that has accumulated in the windings. If left, this moisture can cause corrosion in the winding. Frequent operation of the engine-generator set will also ensure that the set is operating properly should it be needed in an emergency.

## GENERATOR MAINTENANCE

Any major generator service, including the installation or replacement of parts, should be performed only by a qualified electrical service technician. **USE ONLY FACTORY APPROVED REPAIR PARTS.**

- A. Bearing - The bearing used in these generators is a heavy duty, double sealed ball bearing. They require no maintenance or lubrication.
- B. Receptacles - Quality receptacles have been utilized. If a receptacle should become cracked or otherwise damaged, replace it. Using damaged or cracked receptacles can be both dangerous to the operator and destructive to the equipment.

## CLEANING

Remove dirt and debris with a cloth or brush. DO NOT use high pressure spray to clean either the engine or the generator. The high pressure spray could contaminate the fuel system and the generator components.

1. Keep the air inlet screen on both the engine and generator free of any dirt or debris to ensure proper cooling. At least yearly, remove the blower housing on the engine and clean the chaff and dirt out of the engine cooling fins and fly wheel. Clean more often if necessary. Failure to keep these areas clean may cause overheating and permanent damage to the unit.
2. Periodically clean muffler area to remove all grass, dirt, and combustible debris to prevent a fire.
3. On engine mufflers equipped with spark arresters, the spark arrester must be removed every 50 hours for cleaning and inspection. Replace if damaged.

## TROUBLESHOOTING

Problem	Possible Causes
Won't start	Low oil level Fouled spark plug Out of fuel Start switch in OFF position Fuel Valve turned off Plugged fuel filter Blown fuse in key switch
Voltage too low	Engine speed is too low Generator overloaded Defective stator Defective rotor (field) Defective capacitor
Circuit breaker trips	Defective load Defective receptacle Excessive load
Voltage too high	Engine speed is too high
Generator overheating	Overloaded Insufficient ventilation
No output voltage	Short in load (disconnect) Tripped or defective circuit breaker Broken or loose wire Defective receptacle No residual magnetism (in generator) Defective stator Defective rotor (field) Shorted capacitor Shorted diodes on rotor GFCI receptacle tripped

# CONTROL PANEL DIAGRAM

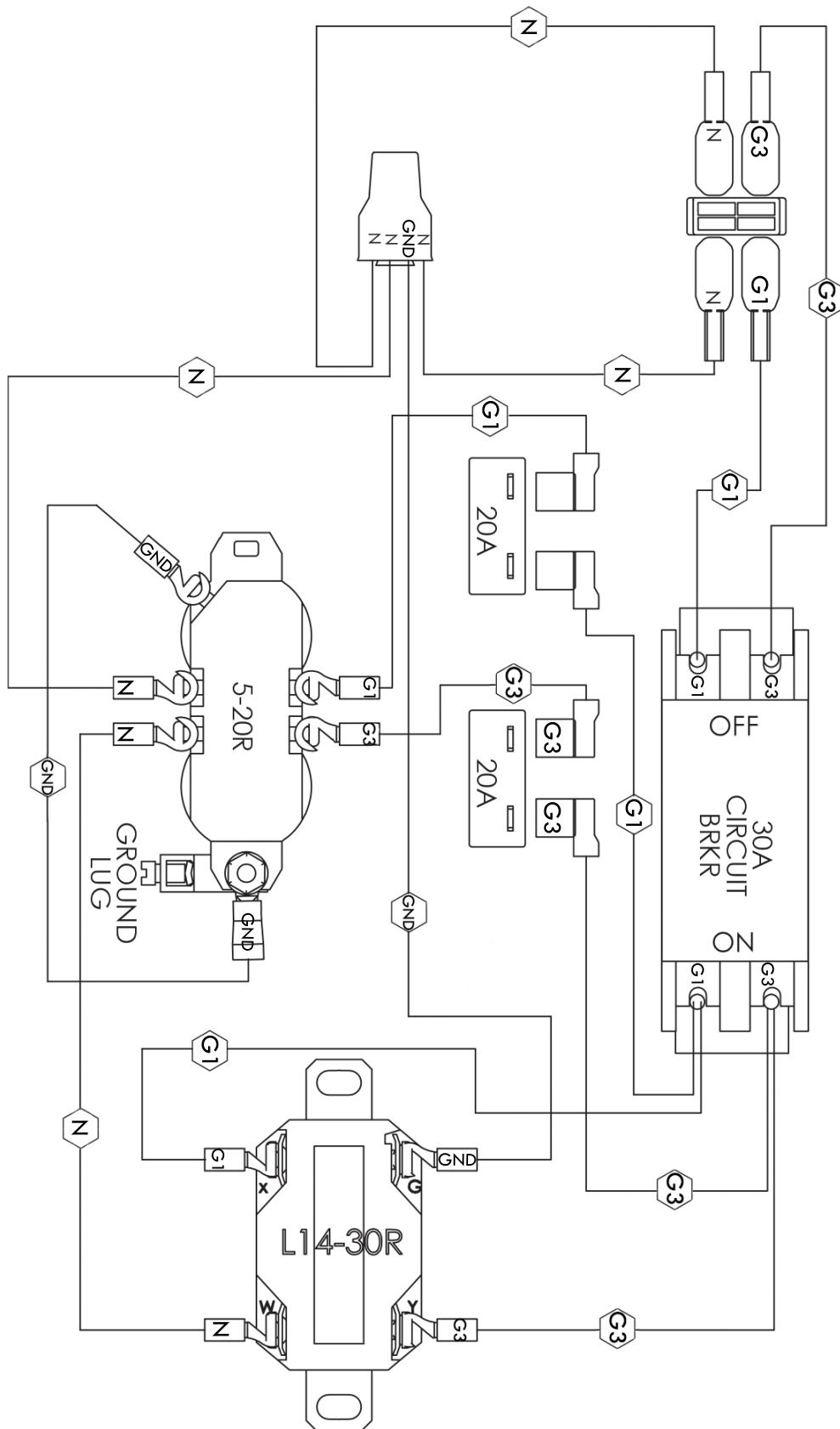



## 24 MONTH LIMITED WARRANTY

WINCO warrants to the original purchaser for 24 months, that goods manufactured or supplied by it will be free from defects in workmanship and material, provided such goods are installed, operated and maintained in accordance with WINCO written instructions and applicable codes.

WINCO's sole liability, and Purchaser's sole remedy for a failure under this warranty, shall be limited to the repair of the product. At WINCO's option, material found to be defective in material or workmanship under normal use and service will be repaired or replaced. For warranty service, return the product within the warranty period, to your nearest WINCO Authorized Service Center or to WINCO in Le Center Minnesota.

Duration Consumer  
Parts & Labor: 24 Months

### EXCLUSIONS:

- Normal maintenance consumables or labor.
- This warranty does not cover travel time, mileage or labor for removal or re-installation of WINCO product from its application.
- Normal wear and tear.
- Costs of rental equipment.
- WINCO does not warrant engines. Engines are covered exclusively by the warranties of their respective manufacturers.
- WINCO does not warrant component parts that are warranted by their respective manufacturers.
- WINCO does not warrant modifications or alterations which were not made by WINCO.
- WINCO does not warrant products which have been subjected to misuse and/or negligence or have been involved in an accident.  
Proof of proper maintenance must be furnished upon request.

THERE ARE NO EXPRESS WARRANTIES OTHER THAN THOSE DESCRIBED HEREIN. THERE ARE NO OTHER WARRANTIES, EXPRESSED OR IMPLIED, OR OTHERWISE CREATED, INCLUDING BUT NOT LIMITED TO WARRANTIES OF MERCHANTABILITY, OR WARRANTIES OF FITNESS FOR A PARTICULAR PURPOSE.

WINCO is liable for the repair or replacement of the product only and is not liable for incidental or consequential damages as permitted by your state. This warranty gives you specific legal rights which may vary from state to state.